

Article number: 201138825

Description: E+G stainless steel-ball lock pin
GN 113.8-8-25

Measures

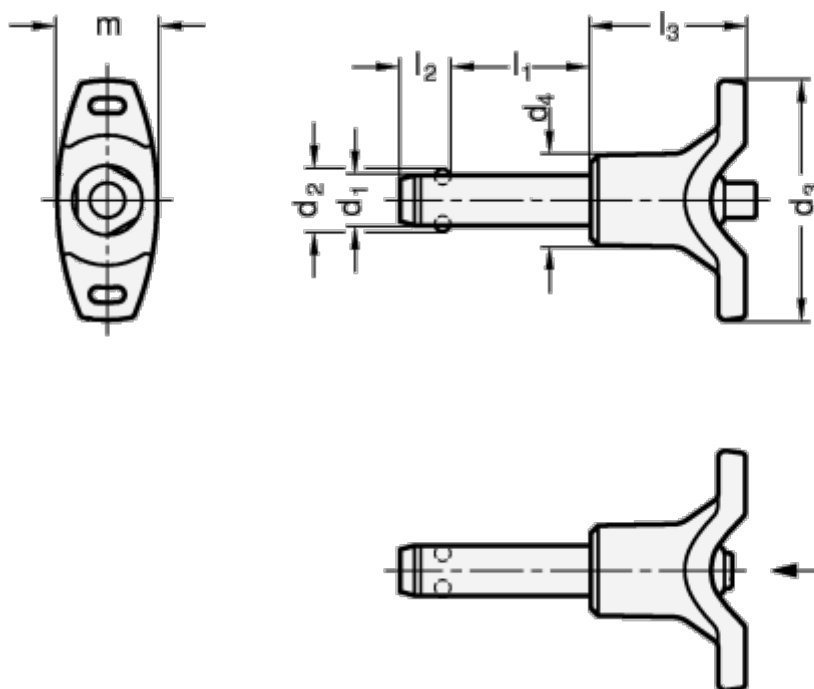

d1 = 8
d2 = 9.5
d3 = 48
d4 = 18.0
l1 = 25
l2 = 8.2
l3 = 31.0
m = 20.5

Resilience (N) = 63